

**TYPICAL SPECIFICATIONS:**  
 Line Pull: 2,500kg  
 Hauling Speed: 0 - 20m/min  
 Capstan Waist Size: 230mm  
 Weight: 160kg  
 Drive: Hydraulic  
 Hydraulic controls to suit application

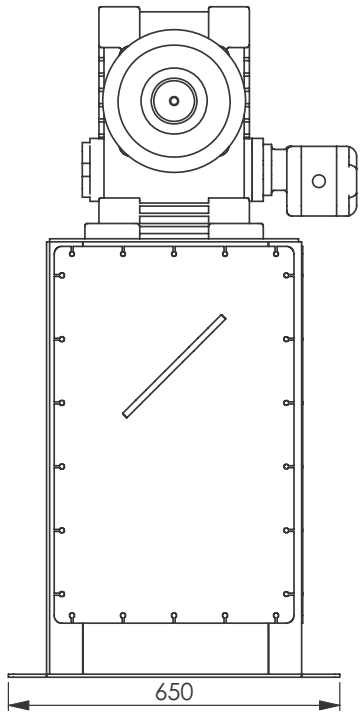
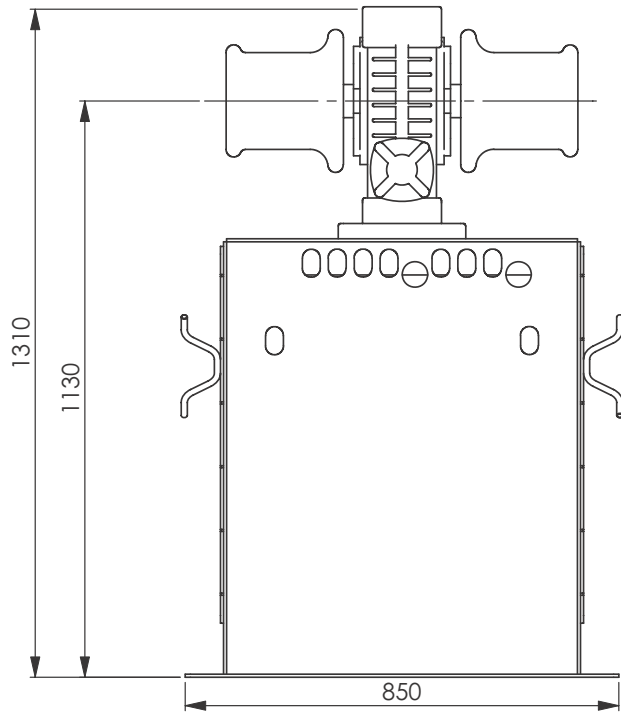
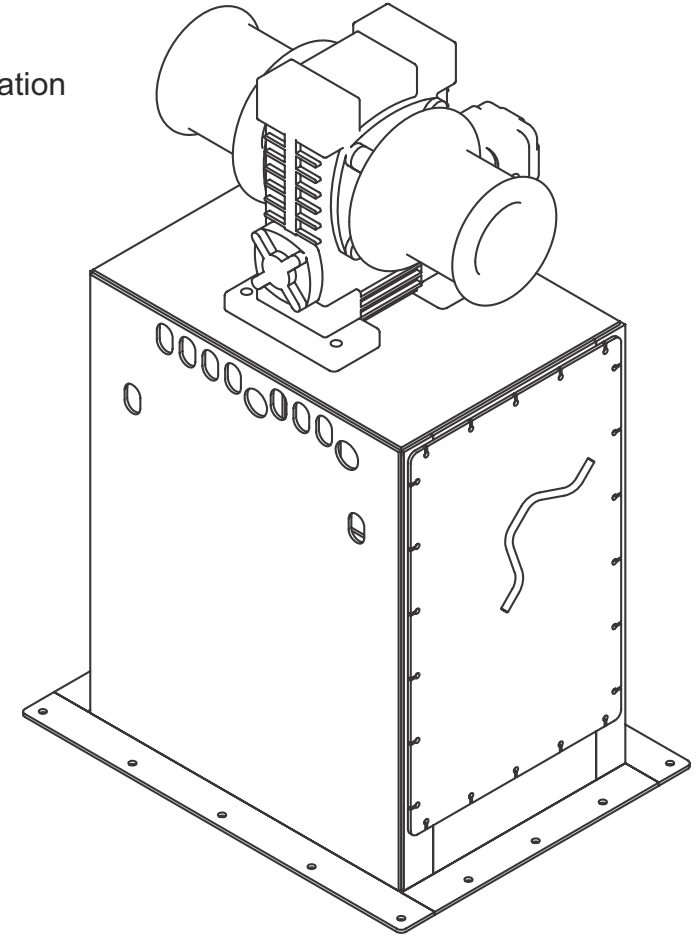

**NEUMANN EQUIPMENT**  
 A Division of Neumann Contractors Pty Ltd  
 PO Box 8 Currumbin, Qld 4223 Australia Ph: +61 7 5589 2746 Fax: +61 7 5589 2775 ABN: 46 009 695 747  
 Email: equipment@neumann.com.au Web: www.neumannequipment.com.au

Description: **CWW2500H**  
**2.5 TONNE CONSOLE CAPSTAN WINCH**

© This drawing and the design shown thereon is the property of Neumann Equipment and must not be sold, lent, given away, copied, reproduced or otherwise divulged to third parties or used for manufacturing of other purposes without the written permissions of Neumann Equipment.