

3T QUICK HITCH CAPSTAN WINCH SPECIFICATIONS

TYPE OF WINCH	CAPSTAN WINCH
RATED LINE PULL (MAXIMUM)	3,000 kg
DIAMETER OF LINEPULL	191 mm
ROPE DIAMETER	16 mm
MAXIMUM LINE SPEED	15 m/min
CAPSTAN DIAMETER	175 mm
HYDRAULIC MOTOR	1000 cc
HYDRAULIC PRESSURE	181.4 BAR
MAX. OIL FLOW REQUIRED	27.3 l/min
MOTOR SPEED	27.28 RPM
POWER REQUIRED	8.1 kW
PAINT SPECIFICATION	NE INDUSTRIAL SPEC
PAINT COLOUR	GOLDEN YELLOW
APPROXIMATE WEIGHT (DRY)	180 kg

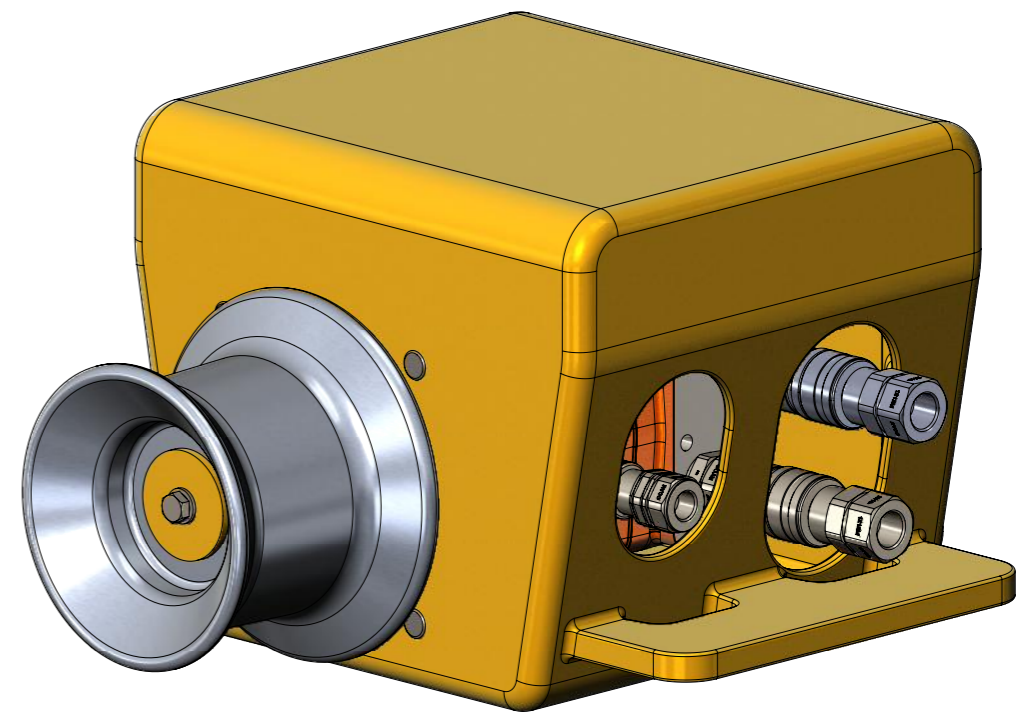

NEUMANN EQUIPMENT
 PO Box 8 Currumbin, Queensland, 4223 Australia Ph: +61 7 5589 2746 Fax: +61 7 5589 2775
 Email: equipment@neumann.com.au Web: neumannequipment.com.au ABN: 46 009 695 747

DESCRIPTION: **QHC3000H**
 3 TONNE QUICK HITCH CAPSTAN WINCH
 SHOWN WITHOUT OPTIONAL QUICK HITCH MOUNT

© This drawing and design shown thereon is the property of NEUMANN EQUIPMENT and must not be sold, lent, given away, copied, reproduced, or otherwise divulged to third parties or used for manufacturing of other purposes without the written permissions of NEUMANN EQUIPMENT.